

Horizon

FOLDING

AFV-56 series TV-56 series

Fully automated functions bring
stable and high quality production.



INCREASED PRODUCTIVITY WITH THE HIGHEST LEVEL OF AUTOMATION.

Newly added functions enable easy operation and maximize quality and productivity.

BENEFIT

USER-FRIENDLY SETUP

Icon based touchscreen enables intuitive setup and operation. New functions allow for automatic and easier setup for each section.

ADVANCED AUTOMATION

Increased deployment of proven automation technology, results in precise set-up and quality folds in record times.

HIGH QUALITY

Uniquely designed buckle plates and folding mechanics ensure consistent folding accuracy across a wide range of substrates.

EASY SETUP

The scoring navigator enables quick, accurate setup of scoring and perforation positions.

APPLICATION FLEXIBILITY

Flexible machine configurations and a variety of options allow for a wide range of applications.

MANAGE YOUR BINDERY WITH PXNET

The system can be enhanced with JDF workflow from upstream to postpress using the Horizon pXnet Bindery Control System.



KEY FEATURES.

INTUITIVE OPERATION

The large, color touch-screen and monitor is icon based for user-friendly operation with minimal training required.

Standard fold patterns are graphically illustrated and selectable. Simple tab selection, drop down windows and easily identifiable icons makes set-up and operation quick and efficient.

With 999 job memory positions unique fold patterns, repeat jobs and unscheduled job interruptions are never a problem.

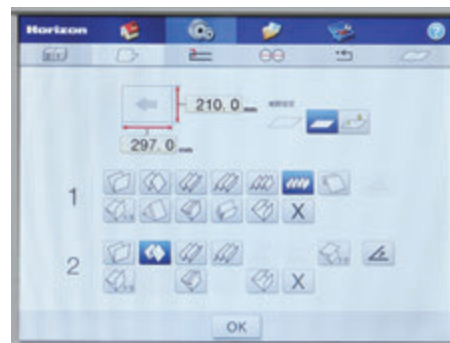

Setup is completed by selecting the desired fold pattern and inputting the sheet size.

FULLY-AUTOMATED SETUP INCREASES EFFICIENCY AND QUALITY

42 sections are automatically setup by inputting the sheet size and fold pattern at the touch-screen.

Fully-automated setup enables any operator to produce consistent, high quality folds with efficiency and high productivity.



Fine-adjustment for skewed folds sets automatically by entering the skewed fold measurement or shift amount of the sheet register guide.



NEW FUNCTIONS FOR HIGH PRODUCTION EFFICIENCY.

AFV-56 and TV-56 series have new and improved features for easy operation.

ROLLER GAP ADJUSTMENT

***For AFV-566DF / 564DF / 566F / 564F**

All fold roller gaps are automatically set by inserting a single strip of paper. Gap setting according to sheet thickness and fold pattern. Set-up time is greatly reduced with elimination of sheet insertion for each roller gap.

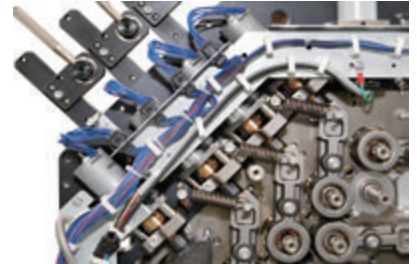

Roller Gap Adjustment (Photo: AFV-56DF / AFV-56F series)

AUTOMATED REGISTER CONVEYOR (AFV-56 SERIES)

- The vacuum register guide sets automatically. Sheets are properly aligned to the guide for folding accuracy.
- Five vacuum chambers adjust automatically for sheet length, coated or uncoated surface. Vacuum can be adjusted individually based on sheet condition.
- Vacuum setting can be memorized for easy recall.
- Efficient blower motors insure long lasting performance and energy efficiency.



RIGHT-ANGLE REGISTER CONVEYOR (TV-56 SERIES)

- Conical drive rollers are used for accurate sheet registration with minimal adjustment required.



BUCKLE PLATE **AFV-566DF / 564DF**

- Uniquely designed buckle plate enables improved folding accuracy and consistency for a wider range of substrates including thinner sheets.
- Specially-coated buckle plates minimize paper friction and static to maintain fold accuracy.
- Optional Dynamic Buckle Plate automatically controls the buckle plate deflector to change fold pattern on-the-fly.



SCORING NAVIGATOR

- Scoring navigator allows operator to adjust accurate scoring and perforation positioning with easy setup procedure.
- Scoring position can be adjusted incrementally by 0.1 mm.
- Settings can be saved to memory for recall on reoccurring jobs.



BRIDGE CONVEYOR (OPTIONS: BGV-56 / BGV-56BBS)

- Bridge conveyor is on slide rail for easy access to the scoring shafts.
- Smooth transfer of sheets to the 2nd fold section, presser stacker or delivery conveyor.
- The BGV-56BBS automatically adjusts to maintain center registration at the BBS-40 book block stacker.

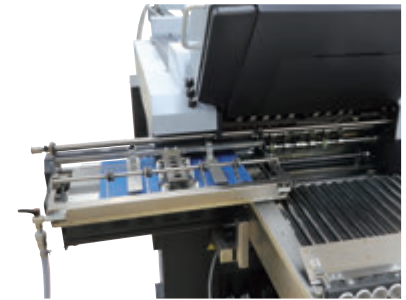

DYNAMIC FOLD **AFV-566DF / 564DF**

- Optional dynamic buckle plate is available for changing the fold patterns on-the-fly for book production. For example, 12 page and 8 page signatures can be produced consecutively to reduce blank pages in the book.



ITEMS FOR AUTOMATED SETUPS		DESCRIPTIONS	FIRST STATION			SECOND STATION	
			AFV-566DF AFV-564DF	AFV-566F AFV-564F	AFV-566A AFV-564A	TV-566F TV-564F	TV-566A TV-564A
Feeder Section	Suction Head	Suction head moves to feeding position according to the sheet length.	Yes	Yes	No	No	No
	Table Guide	Table guide moves to the proper loading position according to sheet width.	Yes	Yes	Yes	No	No
	Vacuum Register Belt	Vacuum register belt moves together with register guide. Sheets align to guide by vacuum. Vacuum level can be adjusted and sets automatically according to sheet quality.	Yes	Yes	Yes	No	No
	Sheet Register Guide	Register guide moves to proper position according to sheet width.	Yes	Yes	Yes	No	No
	Sheet Edge Guide	Sheet edge guide sets to proper position to support sheet edge for smooth sheet transport.	Yes	Yes	Yes	No	No
	Register Guide Angle	Register guide angle can be adjusted from - 4 mm to + 4 mm.	Yes	Yes	Yes	No	No
Fold Section	Sheet Hold-down Guide	Sheet hold-down guide adjusts to sheet width for smooth sheet transfer to fold section.	Yes	Yes	Yes	No	No
	Roller Gap	Roller gap sets up automatically by inputting the single sheet into the caliper.	Yes	Yes	No	Yes	No
	Buckle Stopper	The buckle stopper position is set automatically depending on the sheet size and fold pattern.	Yes	Yes	Yes	Yes	Yes
Right Angle Conveyor	Scoring Position	Score roller position is located automatically based on sheet width and fold pattern.	Yes	Yes	No	No	No
	Register Guide	Sheet register guide sets automatically according to fold pattern at 1st unit.	No	No	No	Yes	Yes
	Sheet Hold-down Guide	Sheet hold-down guides adjust for smooth transfer of sheets to 2nd fold section.	No	No	No	Yes	Yes

DETAILS FOR EACH SECTION.

From feed to finish.

1 TOUCH PANEL DISPLAY

The 12.1 inch color touch-screen is icon-based for user-friendly operation. Setup and operation can be done at the touchscreen. The register conveyor, sheet edge guide, register angle, score adjusting position, and cross-fold register guide are also included in the automated setup function.



Remote Controller

Wired remote controller with jog dial allows for start, stop feeding and test feeding from a remote position. Fine tuning of all automated settings is also possible via the remote control.

2 SUCTION HEAD / ASSIST AIR

Newly designed suction head and feeding system enables easy setup and consistent feeding. Innovative suction head and assist air* provide accurate sheet separation and pick-up. Blowing air volume and height of the suction head can be adjusted according to sheet condition for stable feeding of a wide variety of sheets.

(* The assist air kit SAB-56V with adjustable nozzle height is available as an option.)

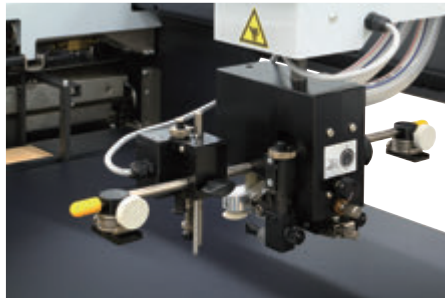

Suction Head

3 FEED ROTOR

Quality polyurethane rotor provides high speed feeding (40,000 sheets per hour) without scratching. The suction angle adjustment enables stable feeding by adjusting the angle of suction air according to the sheet condition. The supersonic and photoelectric double feed detect sensors come standard for superior double feed protection.

Supersonic Sensor

The supersonic double feed sensor works through the transmission of sound waves. Its advanced detection ensures accurate double feed detection even with a solid black printed sheet.

4 SHEET REGISTER GUIDE

The Register guide is coated with a special anti-static plating, for trouble-free folding of printed sheets, even in dry climates, where static can be a problem. Newly-designed register guide ensures stable transportation and accurate registration of a wide range of paper stocks. Automated register conveyor sets each guide depending on the sheet width. A clutch brake on the transport section stops double-fed sheets on the register table. Previously fed sheets are processed through the fold section.

5 BUCKLE PLATE



Uniquely designed buckle plate enables improved folding accuracy and consistency for a wider range of substrates, including thin, light weight sheets. Specially-coated buckle plates minimize paper friction to maintain fold accuracy. For the AFV-566DF and AFV-564DF dynamic folders, uniquely designed automatic gate mechanism enables changing fold pattern on the fly.

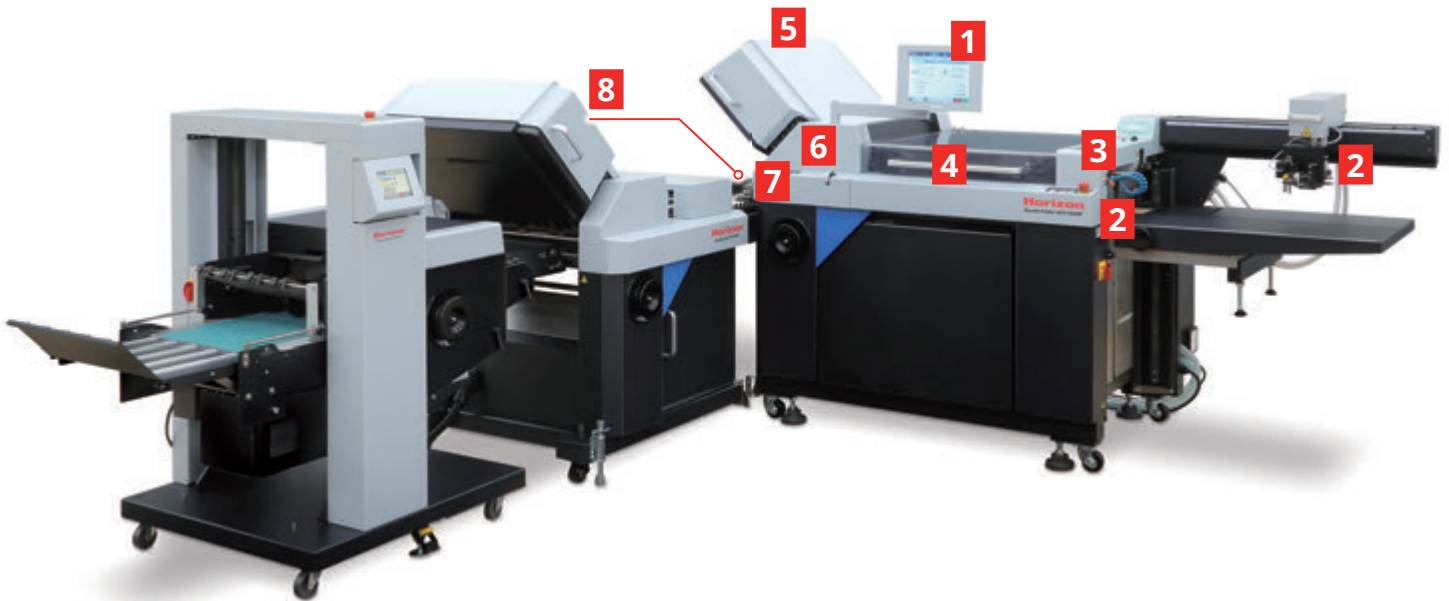

6 FOLD ROLLER

Unique design and precision manufacture insure folding accuracy and long roller life. Soft or hard urethane rollers are available depending upon folding requirements.



Soft urethane roller
(Segmented)
RL-566VS
RL-564VS



Hard urethane roller
(Segmented)
RL-566VH1
RL-564VH1

7 FOLD ROLLER DRIVE

Fold rollers have positive drive with helical gears for maximum folding precision and quiet operation.

8 PERFORATION / SCORING

Perforation, slit perforation, scoring and slitting can be performed. Durable scoring unit is employed for accurate scoring. Optional devices are available for strip trimming of multiple-up jobs, trimming the closed side of glued signatures and punch perforation.

Scoring navigator allows operator to adjust accurate scoring and perforation position. Up/down scoring and drive roller positions are indicated on the touch screen. Set-up time for scoring is greatly reduced even for inexperienced operators.

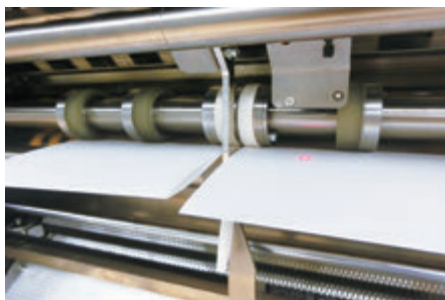

Optional strip trim unit AF-ST5N is attached in the photo.

DETAILS FOR EACH SECTION.

From feed to finish.



9 BRIDGE CONVEYOR

The unit slides outside for easy score position adjustment.



BGV-56

10 RIGHT-ANGLE REGISTER CONVEYOR

Auto adjusting conveyor and guides with conical drive rollers efficiently transfers even complex folded sheets to the 2nd fold section.



11 DELIVERY CONVEYOR (LCVV-56)

A wide belt surface is capable of delivering any size folded piece efficiently. Conveyor height is easily adjusted to the proper sheet delivery height.

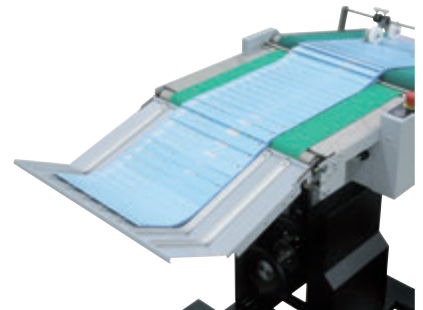

DIGITAL PRINT ENVIRONMENTS.

Workflow Management.

JDF WORKFLOW COMPATIBILITY



The Horizon pXnet system leverages the power of JDF across the bindery, allowing jobs to flow seamlessly through the entire print production process from MIS, Prepress, Press and Postpress.

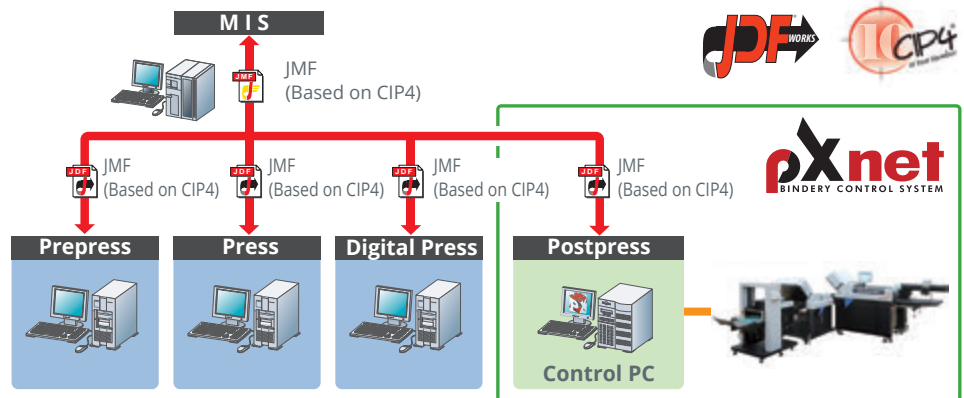

DIGITAL PRINT ENVIRONMENTS

The AFV-566/564DF is incorporated into a Horizon Smart Binding System for production of folded signatures from a printed roll. Sheet length and fold pattern change is handled automatically.

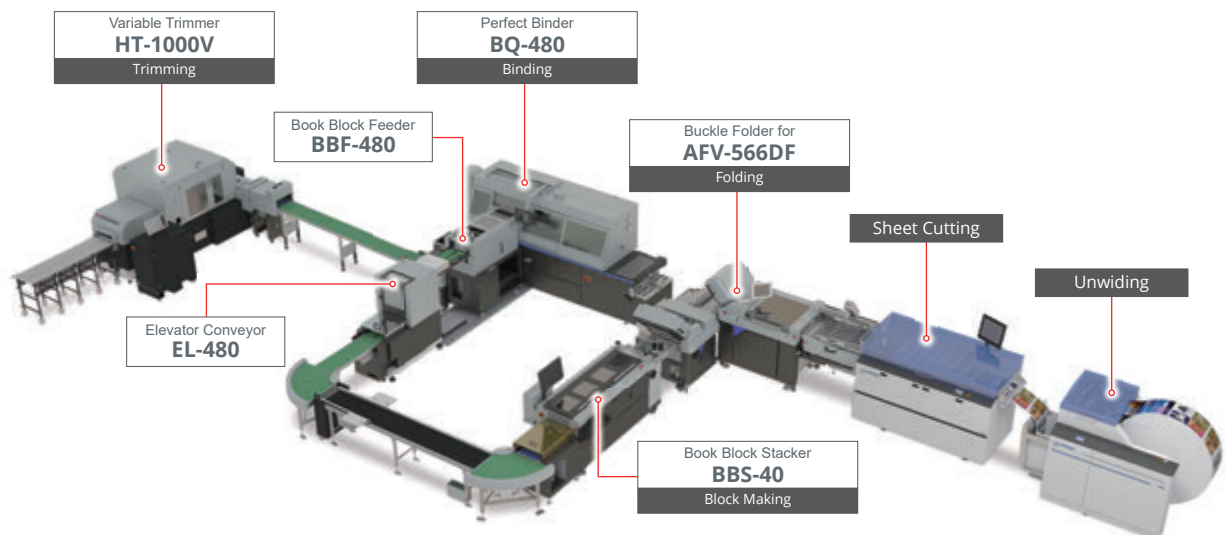

OPTIONS.

Add-on systems.

| DIFV-56 INTERFACE CONVEYOR

- DIFV-56 transports sheets cut from a printed roll to the AFV-566DF. Optional bar code reading allows for variable sheet length and fold pattern change on the fly.



| BBS-40 / BBS-40L BOOK BLOCK STACKER

- Signature book blocks are accumulated and tack glued for downstream processing. Faulty book blocks are automatically rejected.



| PST-66 / PST-44 / PST-44L PRESS STACKER

- First roller removes air between sheets and the second roller presses the sheets tightly to compress the booklets with 12,000N / 4,000N pressure for the PST-66 and PST-44/44L respectively.



| MKU-38 MOBILE KNIFE UNIT

- Rotatable knife unit can fold up or down for a wide range of sheets from 90 to 380 mm width.



MKU-54T MOBILE KNIFE FOLD UNIT

- The MKU-54T is a mobile knife unit equipped with a buckle fold plate under the knife. Letter fold and 8-page cross folds are possible.



MKU-54T

PSX-56 / PSX-56R PRESS STACKER WITH PILE DELIVERY

- Stacked signatures or booklets are delivered to a comfortable height for easy packaging. Applications can be stacked 1-up, 2-up or 3-up for efficient production. Rigid, large diameter rollers apply 1.2 tons of pressure for crisp, tight and flat folds.



ED-40S STANDING DELIVERY UNIT

- Tightly folded pieces are delivered in an orderly, standing position for easy off-loading. An automatic batch kicker makes separation for packaging easy and accurate.

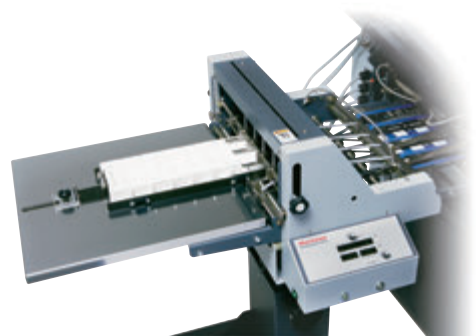

OPTIONS.

Performance Enhancing Options.

GFB-56V GATE FOLD BUCKLE

- The gate fold buckle can be set up quickly, with no special skill for precise, accurate closed gate folding.



BLADES

- A wide variety of optional blades are available for various applications. (Blades in the photo are examples.)

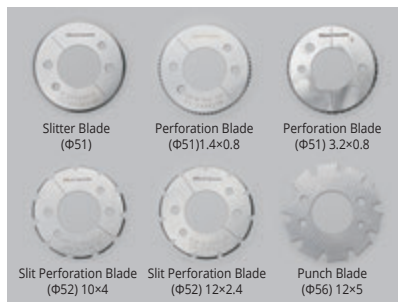

Unit: mm (Cut x Blank)

IC-56V-U / IC-56V-L SHEET CHECKER

- The camera verifies the image on the sheet with the preset image to identify any blank and misloaded sheets.

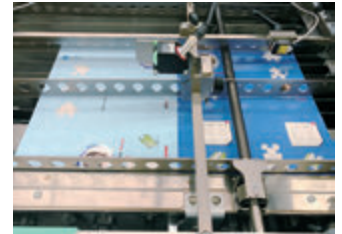

CGU-50 GLUING UNIT

- The gluing unit can produce 8-page or 12-page glued booklets and direct mail applications.

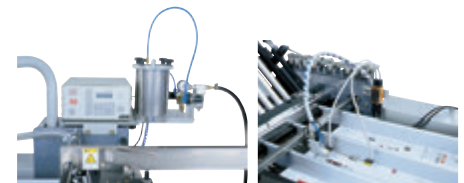

Gluing Unit Controller

Glue Gun

FP-56 / FP-56V / FP-56VP FRONT PERFORATION UNIT

- Accurate perforation before folding is ideal for direct mail applications and page tear out applications. Jump perforation is possible.



FEEDER SECTION

		NAME	MODEL	DESCRIPTION	AFV-566DF	AFV-564DF	AFV-566F	AFV-564F	AFV-566A	AFV-564A
Selection	Pump		P-56V		●	●	●	●	●	●
			P-56VSH	Noise reduction cover is attached. (*- 6 to 8 dB noise reduction)	●	●	●	●	●	●
			P-56VX	Long-life type (Blades are about three times more durable than P-56V.)	●	●	●	●	●	●
	Air Integration Kit	AI-56V	Power saving type of air compressor. The pump is not required.	●	●	●	●	●	●	
	Small Size Kit	SSK-56V	Minimum 105 mm / 4.13" width sheet can be fed.	●	●	●	●	●	●	
	Side Air Blower	SAB-56V	Side blowing assist air for stable feeding.	●	●	●	●	●	●	
	Extension Table	LT-56V	Maximum 1,100 mm / 43.3" sheet can be loaded.	●	●	●	●	●	●	
	Interface Unit	DIFV-56	Transports the sheets cut from the roll paper to the AFV-566DF.	●	●	●	●	No	No	
	Barcode Reader Kit	BR-56DF	Reads the data matrix to switch the fold pattern for dynamic folding.	○	○	No	No	No	No	

We have various kinds of options and peripheral equipment other than the ones listed below. Please contact local dealer for detailed information.
○: Options ●: Retrofittable options

FOLDING / PERFORATION / SCORING SECTION

NAME	MODEL	DESCRIPTION	AFV-566DF	AFV-564DF	AFV-566A	AFV-564A	TV-566F	TV-564F
			AFV-566F	AFV-564F			TV-566A	TV-564A
Front Perforation Unit	FP-56V	Removable metal anvil roller is used for front perforation unit. Only available as factory option.	○	○	○	○	No	No
	FP-56VP	Removable resinous roller used for front perforation unit. Only available as factory option.	○	○	○	○	No	No
Selection Steel and Soft-formed Polyurethane Combination Roller	RL-566VS	8 rollers for 6 buckle plate unit	○	No	○	No	○	No
	RL-564VS	6 rollers for 4 buckle plate unit	No	○	No	○	No	○
	RL-566VH1	8 rollers for 6 buckle plate unit	○	No	○	No	○	No
	RL-564VH1	6 rollers for 4 buckle plate unit	No	○	No	○	No	○
Rigid Urethane Roller								
Skip Perforation Unit	JM-AF	Perforation head for skip perforation	●	●	●	●	No	No
Skip Perforation Control Unit	JM-C56V	Controller for JM-AF	○	○	○	○	No	No
Cold Glue Unit	CGU-50	Gluing unit produces 8-page or 12-page glued booklets and direct mail applications.	●	●	●	●	No	No
Glueing Unit Attachment Kit	CGU-K56V	A attachment kit for CGU-50	○	○	○	○	No	No
Soft PU Roller with Groove	RL-CG56VS	Fixed center groove roller	○	○	○	○	No	No
Segment Soft PU Roller	RL-SEG56VS	Segmented roller for adjustable gluing location	○	○	○	○	No	No
Segmented Buckle Plate	SGB-56V	Segmented plate for adjustable gluing position	●	●	●	●	No	No
Image Checker	IC-56V-U	A camera scans the top surface of sheets to identify any blank or misloaded sheets.	●	●	●	●	No	No
Image Checker	IC-56V-L	A camera scans the bottom surface of sheets to identify any blank or misloaded sheets.	●	●	●	●	No	No
Gatefold Buckle	GFB-56V	Gate fold buckle to produce closed gate fold application.	●	●	●	●	●	●
Bridge Conveyor	BGV-56	Bridge conveyor between first and second station.	●	●	●	●	●	●
Automated Bridge Conveyor	BGV-56BBS	Feed position sets automatically with the register guide on right-angled station for stable sheet transportation.	●	●	●	●	No	No

We have various options and peripheral equipment other than the ones listed below. Please contact local dealer for detailed information.
○: Options ●: Retrofittable options

DELIVERY SECTION

NAME	MODEL	DESCRIPTION	NOTES
Long Conveyor	LCVV-56	Standard delivery conveyor	
Press Stacker	PST-44 / PST-44L	Up to 440 mm / 17.3" width sheets can be received. 4 kN of pressure can be applied for tighter fold quality.	Adapter cables CMC-P5V15 and BGV-56V are necessary.
	PST-66	Up to 660 mm / 26" width sheets can be received. 1.2 tons of pressure can be applied for tighter fold quality.	
Press Stacker with Pile Delivery	PSX-56 / PSX-56R	Press stacker which can stack up to 200 mm / 7.8" height. 1,2 or 3-up stacks are possible.	Adapter cables CMC-P4V and BGV-56V are necessary.
Mobile Knife Fold Unit	MKU-54T	Mobile knife unit with buckle under the knife	Adapter cables CMC-P4V and BGV-56V are necessary.
	MKU-38	Mobile knife unit for up or down fold	
Standing Delivery Unit	ED-40S	Standing delivery	
Standing Delivery	BBS-40 / BBS-40L	Standing delivery for direct mail and small piece delivery	Adapter cables CMC-P5V15 and BGV-56BBS are necessary.
Adopter Cable	CMC-P3V	Cable for PST-40 / T-56A / ED-40S	
	CMC-P4V	Cable for PSX-56 / MKU	BGV-56V is necessary to connect the PSX-56 / MKU-38 / MKU-54T.
	CMC-P5V15	Cable for PST-44 / PST-66 / BBS-40	BGV-56V is necessary to connect the PST-66. BGV-56BBS is necessary to connect the BBS-40.

OTHERS

NAME	MODEL	DESCRIPTION
JDF Network System	pXnet	Automated bindery control system with JDF workflow.

SPECIFICATIONS.

Machine Dimensions.

(Unit: mm or inch)

Flexible modular concept increases folding capabilities.

	MODELS	NUMBER OF BUCKLES	AUTOMATION	DYNAMIC FOLD (OPTIONAL)
First Station	AFV-566DF	6	Full-automatic	•
	AFV-564DF	4	Full-automatic	•
	AFV-566F	6	Full-automatic	No
	AFV-564F	4	Full-automatic	No
	AFV-566A	6	Semiautomatic	No
	AFV-564A	4	Semiautomatic	No
Second Station	TV-566F	6	Full-automatic	No
	TV-564F	4	Full-automatic	No
	TV-566A	6	Semiautomatic	No
	TV-564A	4	Semiautomatic	No

* We cannot accommodate a change of number of buckles and type of automation after the shipment.

CONFIGURATION 1

■ Stand-alone 6-buckle

Stand-alone 6-buckle or 4-buckle configuration for brochure or leaflet folding.



AFV-56 series + LCVV-56

(Top View)

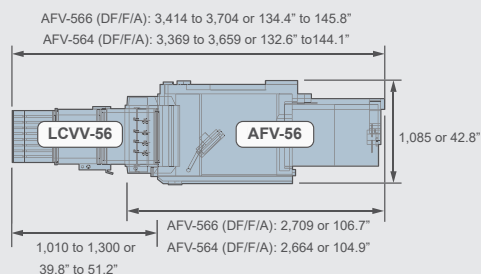

CONFIGURATION 2

■ Right Angle 6/4 Buckle system

Buckle folding system is available with 4 or 6 buckle plates in both the parallel and right angle sections. Right angle configuration expands folding patterns for applications, including direct mail and book signatures. This configuration also allows for scoring in the first station and folding on the second station for heavier weight stocks.



AFV-56 Series + TV-56 Series + PST-44L

(Top View)

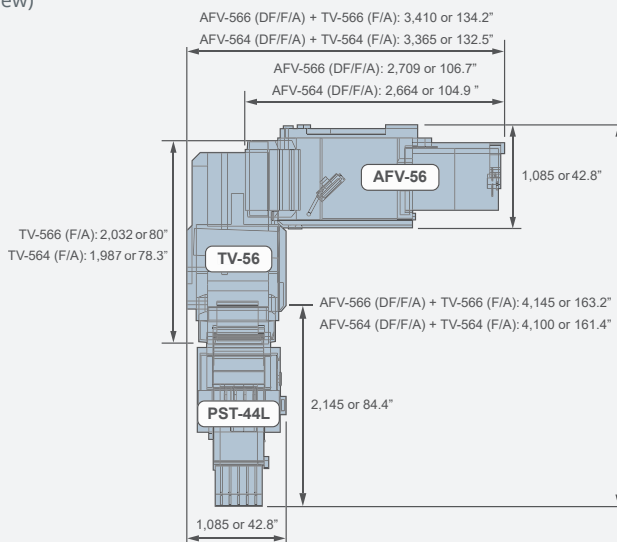

CONFIGURATION 3

■ In-line 6/6 Buckle System

Straight 6/6 (4)-buckle modular system for maximum 10 or 12-buckle operation. Complex fold patterns can be performed with this configuration.



AFV-56 series + TV-56 series + PST-44L

(Top View)

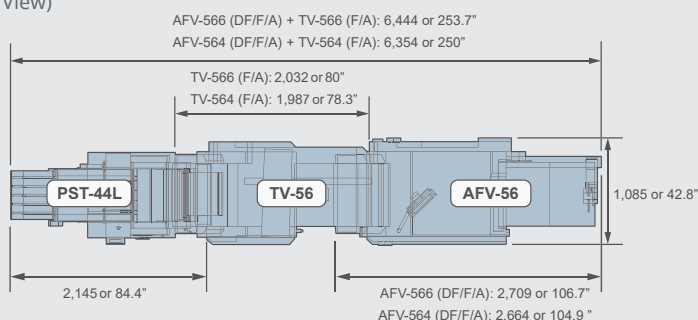

AFV-56 SERIES / TV-56 SERIES SPECIFICATIONS

Machine Configuration	First Station (AFV-56) AFV-566(DF/F/A): 6 Buckles AFV-564(DF/F/A): 4 Buckles	
	Second Station (TV-56) TV-566(F/A): 6 Buckles TV-564(F/A): 4 Buckles	
Sheet Size	 <p>Width x Length Max. 560 mm x 900 mm or 22.04" x 35.43" * 1,100 mm or 43.310" with optional long table Min. 130 mm x 148 mm * 105 mm or 4.14" with optional small guide</p>	
Sheet Weight Range	Uncoated Paper 40 to 250 gsm Coated Paper 50 to 232 gsm	
Belt Speed	30 to 270 meters per minute or 98 to 885 feet per minute	
Production Speed	Suction Head 40,000 cycle per hour	
Buckle Fold Length	AFV-56 1st Buckle Chute 35 to 450 mm or 1.375" to 17.700" 2nd Buckle Chute 35 to 450 mm or 1.375" to 17.700" 3rd Buckle Chute 35 to 450 mm or 1.375" to 17.700" 4th Buckle Chute 35 to 330 mm or 1.375" to 12.990" 5th Buckle Chute 35 to 450 mm or 1.375" to 17.700" 6th Buckle Chute 35 to 330 mm or 1.375" to 12.990"	
	TV-56 1st Buckle Chute 35 to 330 mm or 1.375" to 12.990" 2nd Buckle Chute 35 to 330 mm or 1.375" to 12.990" 3rd Buckle Chute 35 to 330 mm or 1.375" to 12.990" 4th Buckle Chute 35 to 330 mm or 1.375" to 12.990" 5th Buckle Chute 35 to 330 mm or 1.375" to 12.990" 6th Buckle Chute 35 to 330 mm or 1.375" to 12.990"	
	Voltage/Frequency	AFV-566DF, 566F, 566A, 564DF, 564F, 564A 3-phase 200 to 230 V, 50 or 60 Hz 3-phase 380 or 400 or 415 V, 50 or 60 Hz (Step down to 200 V by Transformer) TV-566F, 566A, 564F, 564A 3-phase 200 to 230 V, 50 or 60 Hz
	Machine Dimensions	AFV-566DF, 566F, 566A: W2,709 x D1,085 x H1,526 mm or W106.7" x D42.8" x H60.1"
		AFV-564DF, 564F, 564A: W2,664 x D1,085 x H1,481 mm or W104.9" x D42.8" x H58.4"
		TV-566F, 566A: W2,032 x D1,085 x H1,412 mm or W80" x D42.8" x H55.6" TV-564F, 564A: W1,987 x D1,085 x H1,412 mm or W78.3" x D42.8" x H55.6"

PST-66 SPECIFICATIONS

Signature Size	 <p>Maximum Width With Offset Delivery: 660 mm or 25.984" Without Offset Delivery: 690 mm or 27.165" (In either delivery, the maximum width is 380 mm or 14.96" when the extension belt section is used.) Minimum Length 50 mm or 1.969" (When the extension belt section is used)</p>
Signature/Booklet Thickness	Max. 4 mm or 0.15"
Production Speed	Press Roller Speed: 30 to 180 m per minute
Offset Amount	30 mm or 1.18"
Number of Press Rollers	Air Remove Roller x 1, Press Roller x 1
Voltage/Frequency	3-phase 200 to 220 V, 50 or 60 Hz Single Phase 200 to 240 V, 50 or 60 Hz
Machine Dimensions	W2,145 x D1,159 x H1,359 mm or W84.5" x D45.7" x H53.6"

PST-44 / PST-44L

Signature Size	 <p>Maximum Width With Offset Delivery: 440 mm or 17.322" Without Offset Delivery: 470 mm or 18.503" (In either delivery, the maximum width is 380 mm or 14.96" when the extension belt section is used.) Minimum Length 50 mm or 1.969" (When the extension belt section is used)</p>
Signature/Booklet Thickness	Max. 4 mm or 0.15"
Production Speed	Press Roller Speed: 30 to 180 m per minute
Offset Amount	30 mm or 1.18"
Number of Press Rollers	Air Remove Roller x 1, Press Roller x 1
Voltage/Frequency	3-phase 200 to 220 V, 50 or 60 Hz Single Phase 200 to 240 V, 50 or 60 Hz
Machine Dimensions	PST-44: W1,845 x D980 x H1,359 mm or W72.7" x D38.6" x H53.6" PST-44L: W2,145 x D980 x H1,359 mm or W84.5" x D38.6" x H53.6"

MKU-54T SPECIFICATIONS

Signature Size	 <p>Width x Length Max. 538 x 350 mm or 21.1" x 13.7" Min. 165 x 80 mm or 6.5" x 3.2"</p>
Sheet Weight Range	Uncoated Paper 35 to 244 gsm
Belt Speed	50 to 180 meters per minute
Max. Folding Thickness	Max. 0.6 mm or 0.024"
Buckle Fold Length	Booklet of 12 pages [81 gsm], Booklet of 16 pages [64 gsm]
Buckle Fold Length	60 to 150 mm or 2.36" to 5.90" (Manual Setting)
Voltage/Frequency	Single Phase 208 to 240 V, 50 or 60 Hz
Machine Dimensions	W860 x D1,180 x H1,280 mm or W33.9" x D46.5" x H50.4"

MKU-38 SPECIFICATIONS

Signature Size	 <p>Width x Length Max. 380 x 280 mm or 14.9" x 11.0" Min. 90 x 20 mm or 3.6" x 0.8"</p>
Sheet Weight Range	Uncoated Paper 35 to 210 gsm
Belt Speed	30 to 180 meters per minute 99 to 590 feet per minute
Max. Folding Thickness	Up to 2.3 mm or 0.09" thickness of folded sheet
Voltage/Frequency	Single Phase 200 to 240 V, 50 or 60 Hz
Machine Dimensions	W685 x D858 x H1,283.5 mm or W27.0" x D33.8" x H50.6"

PSX-56 / PSX-56R SPECIFICATIONS

Signature Size	 <p>Width x Length Max. 546 x 330 mm or 21.496" x 12.992" Min. 128 x 92 mm or 5.04" x 3.622"</p>
Signature/Booklet Thickness	Max. 4 mm or 0.15"
Stack Height	Max. 200 mm or 7.87", Min. 10 mm or 0.40"
Production Speed	Max. 900 stacks per hour (With continuous motion of the pushers)
Number of Press Rollers	Two Sets (Air Remove Roller, Press Roller)
Voltage/Frequency	3-phase 200 to 220 V, 50 or 60 Hz Single Phase 200 to 240 V, 50 or 60 Hz
Machine Dimensions	W2,120 x D2,280 x H1,080 mm or W83.5" x D89.8" x H42.6"

ED-40S SPECIFICATIONS

Signature Size	 <p>Maximum Width 400 mm or 15.74" Maximum Height 150 mm or 5.90" Minimum Width 30 mm or 1.19" Minimum Height 20 mm or 0.79"</p>
Thickness of Folded Piece	Max. 3 mm or 0.12"
Stack Capacity	Max. 395 mm or 15.55", Min. 5 mm or 0.20"
Belt Speed	30 to 160 meters per minute
Offset Amount	Minimum Offset: Five sheets
Voltage/Frequency	Single Phase 200 to 240V, 50 or 60 Hz
Machine Dimensions	W982 x D624 x H1,153 mm or W38.7" x D24.6" x H45.4"

BBS-40 / BBS-40L SPECIFICATIONS

Signature Size	 <p>Width x Length Max. 385 x 275 mm or 15.15" x 10.82" Min. 148 x 105 mm or 5.83" x 4.13"</p>
Signature/Booklet Thickness	Max. 2 mm or 0.15" Min. 0.2 mm or 0.008"
Stack Height	Max. 80 mm or 3.14" Min. 2 mm or 0.08"
Delivery Height	BBS-40: 900 mm or 35.5" BBS-40L: 700 mm or 27.6"
Production Speed	Press Roller Speed: 50 to 160 meters per minute Transport Section Speed: 30 to 80 meters per minute Delivery Section Conveyor: 20 to 40 meters per minute Infeed speed: 16,000 sheets per hour Output Cycle: Max. 2,000 blocks per hour
Number of Press Rollers	Air Remove Roller x 1, Press Roller x 1
Voltage/Frequency	Single Phase 200 to 240 V, 50 or 60 Hz
Machine Dimensions	BBS-40: W2,910 x D830 x H1,135 mm or W114.6" x D32.7" x H44.7" BBS-40L: W2,910 x D830 x H935 mm or W114.6" x D32.7" x H36.9"

*The machine design and specifications are subject to change without any notice.

MORE AT
HORIZON.CO.JP



Horizon

Horizon International, Inc.

510 Kuze Ooyabu-cho, Minami-ku,
Kyoto, 601-8206, Japan
Phone : +81-75-934-6700
Fax : +81-75-934-6708
www.horizon.co.jp

Horizon GmbH

Pascalstrasse 20
25451 Quickborn / Germany
Phone : +49 4106 8042-0
Fax : +49 4106 8042-199
www.horizon.de